

Features

- 500mW Power Dissipation on Ceramic PCB
- Very Tight Tolerance on V_Z
- Ideally Suited for Automated Assembly Processes
- **Lead, Halogen and Antimony Free, RoHS Compliant "Green" Device (Notes 2 and 3)**
- **Qualified to AEC-Q101 Standards for High Reliability**

Mechanical Data

- Case: SOD-123
- Case Material: Molded Plastic. UL Flammability Classification Rating 94V-0
- Moisture Sensitivity: Level 1 per J-STD-020D
- Terminal Connections: Cathode Band
- Terminals: Finish - Matte Tin annealed over Alloy 42 leadframe. Solderable per MIL-STD-202, Method 208
- Marking Information: See Page 6
- Ordering Information: See Page 6
- Weight: 0.01 grams (approximate)



Top View

Maximum Ratings @ $T_A = 25^\circ\text{C}$ unless otherwise specified

Characteristic	Symbol	Value	Unit
Forward Voltage @ $I_F = 10\text{mA}$	V_F	0.9	V

Thermal Characteristics

Characteristic	Symbol	Value	Unit
Power Dissipation (Note 1)	P_D	500	mW
Thermal Resistance, Junction to Ambient Air (Note 1)	$R_{\theta JA}$	305	$^\circ\text{C/W}$
Operating and Storage Temperature Range	T_J, T_{STG}	-65 to +150	$^\circ\text{C}$

- Notes:
1. Device mounted on ceramic PCB; 7.6mm x 9.4mm x 0.87mm with pad areas 25mm².
 2. No purposefully added lead. Halogen and Antimony Free.
 3. Product manufactured with Data Code V9 (week 33, 2008) and newer are built with Green Molding Compound. Product manufactured prior to Date Code V9 are built with Non-Green Molding Compound and may contain Halogens or Sb₂O₃ Fire Retardants.

Electrical Characteristics @T_A = 25°C unless otherwise specified

Type Number	Marking Code	Zener Voltage Range (Notes 4, 5)			Maximum Zener Impedance (Note 6)			Maximum Reverse Current (Note 7)	
		V _Z @ I _{ZT}		I _{ZT}	Z _{ZT} @ I _{ZT}	Z _{ZK} @ I _{ZK}	I _{ZK}	I _R	@ V _R
		Min (V)	Max (V)	mA	Ω		mA	uA	V
DDZ5V1B	KM	4.94	5.20	20	17	480	1	5	1.5
DDZ5V6B	KN	5.45	5.73	20	11	400	1	0.5	2.5
DDZ6V2B	KO	5.96	6.27	20	7	150	1	0.5	4.0
DDZ6V8B	KP	6.49	6.83	20	5	150	0.5	0.1	5.0
DDZ6V8C	YP	6.66	7.01	20	5	150	0.5	0.1	5.0
DDZ7V5B	KQ	7.07	7.45	20	6	120	0.5	0.1	6.0
DDZ7V5C	YQ	7.29	7.67	20	6	120	0.5	0.1	6.0
DDZ8V2B	KR	7.78	8.19	20	8	120	0.5	0.1	6.5
DDZ8V2C	YR	8.03	8.45	20	8	120	0.5	0.1	6.5
DDZ9V1B	KS	8.57	9.01	20	8	120	0.5	0.1	7.0
DDZ9V1C	YS	8.83	9.30	20	8	120	0.5	0.1	7.0
DDZ10B	KT	9.41	9.90	20	8	120	0.5	0.1	8.0
DDZ10C	YT	9.70	10.20	20	8	120	0.5	0.1	8.0
DDZ11B	KU	10.50	11.05	10	10	120	0.5	0.1	8.4
DDZ11C	YU	10.82	11.38	10	10	120	0.5	0.1	8.4
DDZ12B	KV	11.44	12.03	10	12	110	0.5	0.1	9.1
DDZ12C	YV	11.74	12.35	10	12	110	0.5	0.1	9.1
DDZ13B	KW	12.55	13.21	10	14	110	0.5	0.1	10.0
DDZ14	GX	13.65	14.35	10	16	110	0.5	0.05	11.0
DDZ14B	KX	13.89	14.62	10	16	110	0.5	0.05	11.0
DDZ15	GY	14.80	15.57	10	18	150	0.5	0.05	12.0
DDZ16B	KY	15.25	16.04	10	18	150	0.5	0.05	12.0
DDZ16	YY	15.69	16.51	10	18	150	0.5	0.05	12.0
DDZ17	KZ	16.82	17.70	10	23	150	0.5	0.05	14.0
DDZ18C	YZ	17.42	18.33	10	23	150	0.5	0.05	14.0
DDZ19	ZJ	18.63	19.59	10	28	200	0.5	0.05	15.0
DDZ20C	PJ	19.23	20.22	10	28	200	0.5	0.05	15.0
DDZ21	ZK	20.64	21.71	5	30	200	0.5	0.05	17.0
DDZ22D	2K	21.52	22.63	5	30	200	0.5	0.05	17.0
DDZ23	ZL	22.61	23.77	5	35	200	0.5	0.05	19.0
DDZ24C	PL	23.12	24.31	5	35	200	0.5	0.05	19.0
DDZ26	ZM	24.97	26.26	5	45	250	0.5	0.05	21.0
DDZ27D	2M	26.29	27.64	5	45	250	0.5	0.05	21.0
DDZ28	ZN	27.70	29.13	5	55	250	0.5	0.05	23.0
DDZ30D	2N	29.02	30.51	5	55	250	0.5	0.05	23.0
DDZ31	ZO	30.32	31.88	5	65	250	0.5	0.05	25.0
DDZ33	RP	32.14	33.79	5	75	250	0.5	0.05	27.0
DDZ34	ZP	32.79	34.49	5	75	250	0.5	0.05	27.0
DDZ36	ZQ	35.36	37.19	5	85	250	0.5	0.05	30.0
DDZ39F	5Q	38.02	39.98	5	85	250	0.5	0.05	30.0
DDZ43	ZR	42.14	43.86	5	90	—	—	0.05	33.0

- Notes:
- The Zener voltage is measured 40ms after power is supplied.
 - For inquiries on tighter tolerances, or alternate nominal zener voltages, please contact your Diodes Inc. sales representative for availability and minimum order details.
 - f = 1kHz.
 - Short duration pulse test used to minimize self-heating effect.

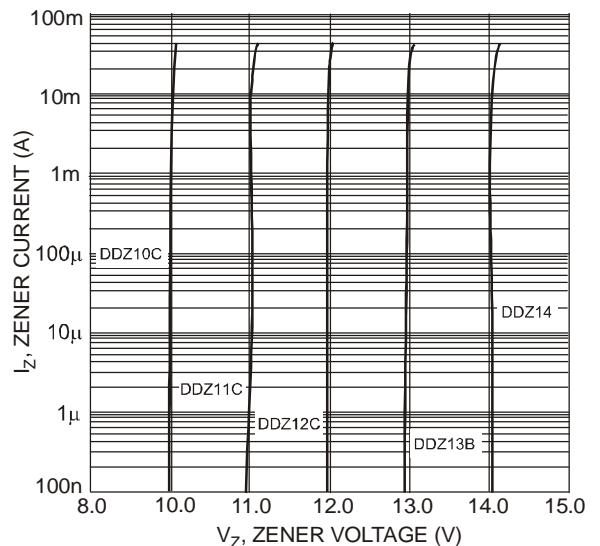
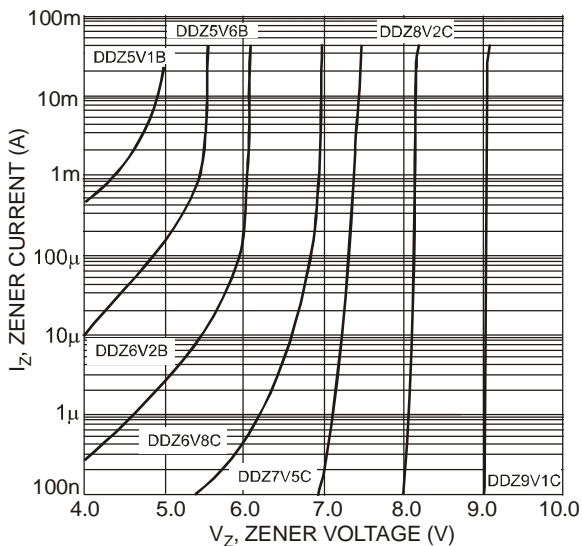
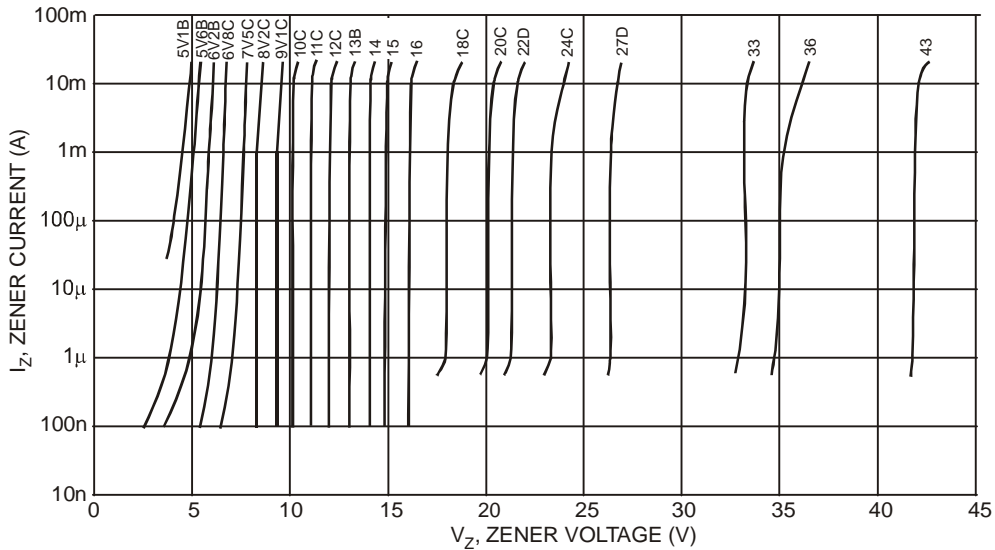
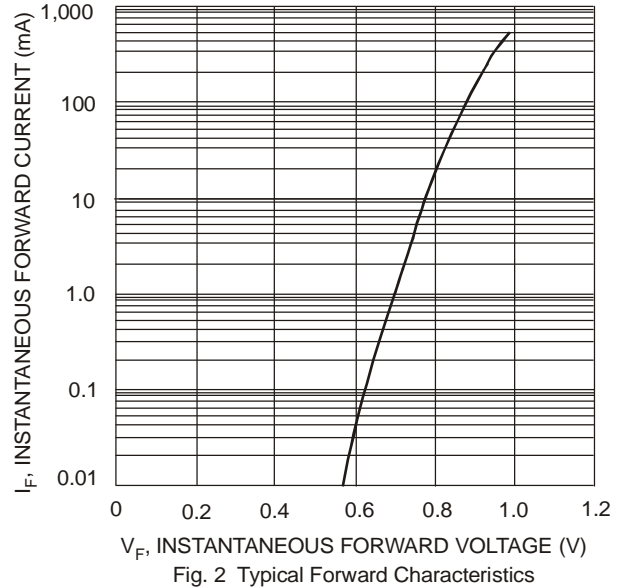
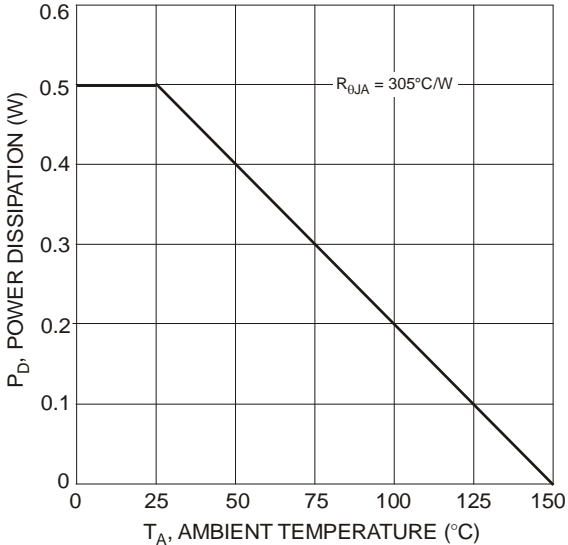

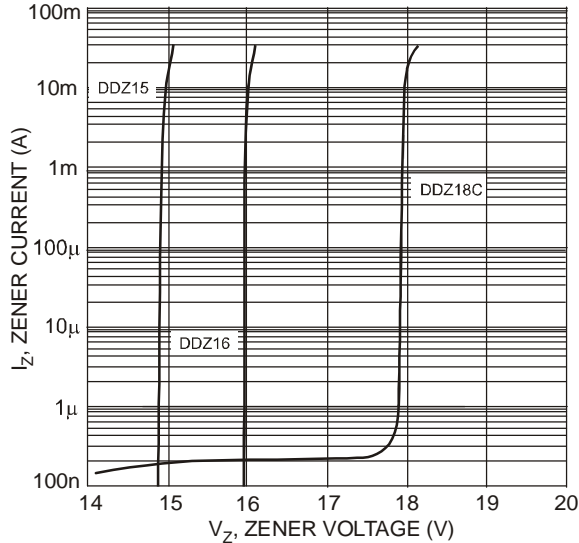

Fig. 6 Typical Zener Breakdown Characteristics, DDZ15 - DDZ18C

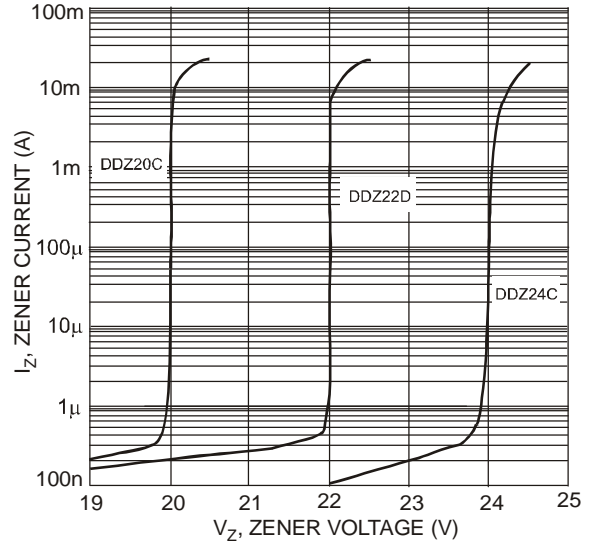

Fig. 7 Typical Zener Breakdown Characteristics, DDZ20C - DDZ24C

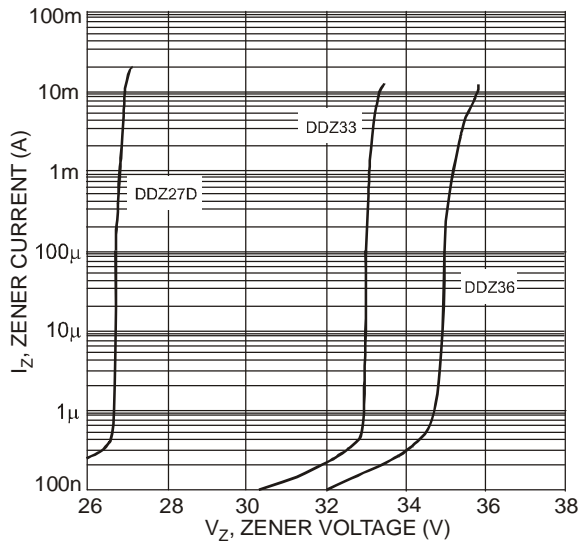

Fig. 8 Typical Zener Breakdown Characteristics, DDZ27D - DDZ36

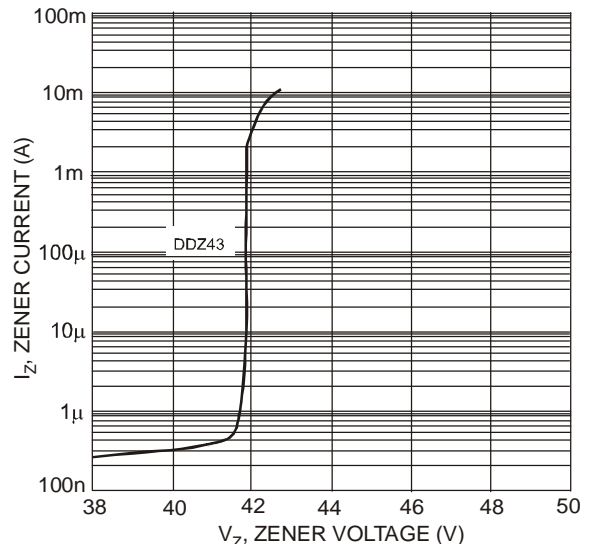

Fig. 9 Typical Zener Breakdown Characteristics, DDZ43

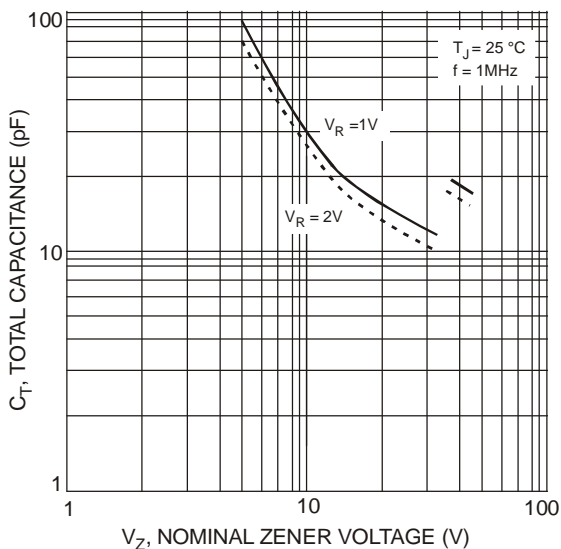

Fig. 10 Typical Total Capacitance vs. Nominal Zener Voltage

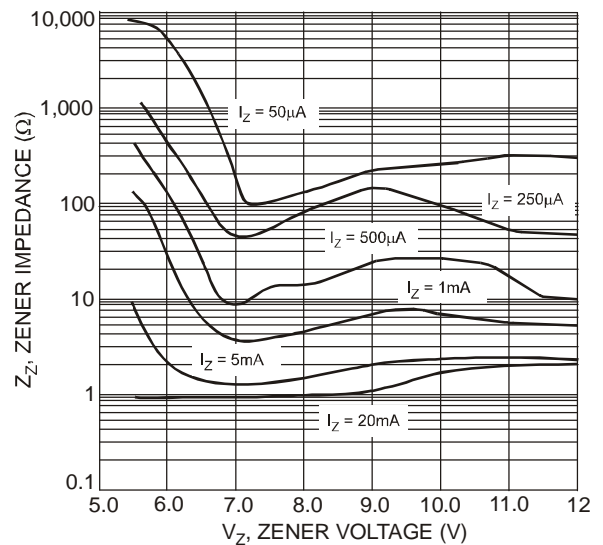

Fig. 11 Typical Zener Impedance Characteristics, DDZ5V6B - DDZ12C

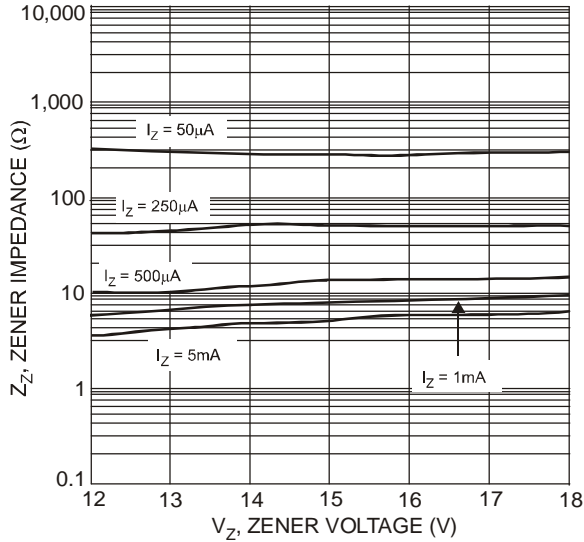

Fig. 12 Typical Zener Impedance Characteristics, DDZ12C - DDZ18C

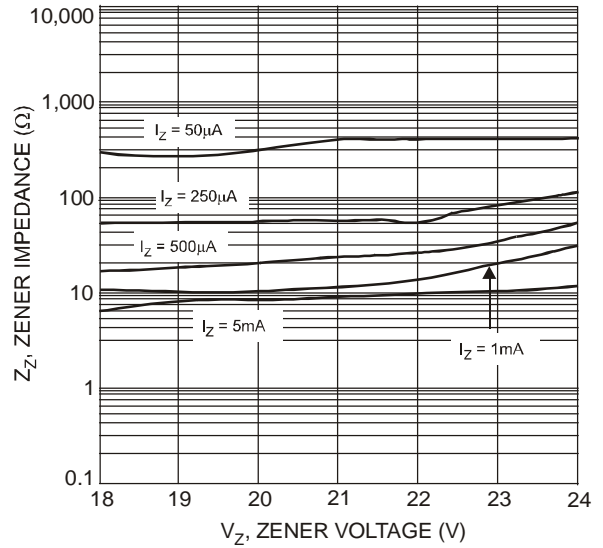

Fig. 13 Typical Zener Impedance Characteristics, DDZ18C - DDZ24C

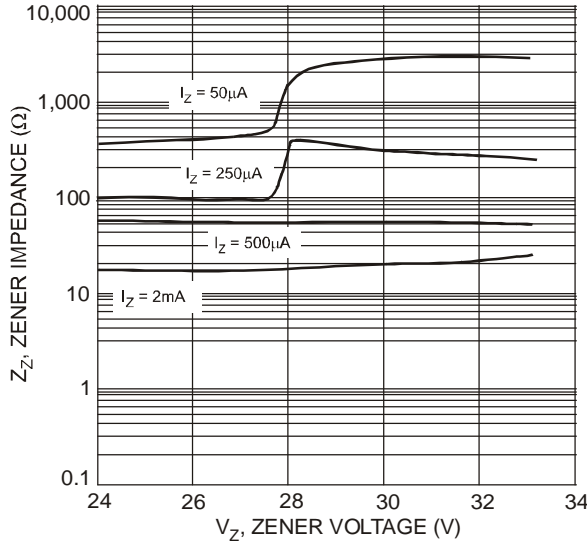

Fig. 14 Typical Zener Impedance Characteristics, DDZ24C - DDZ33

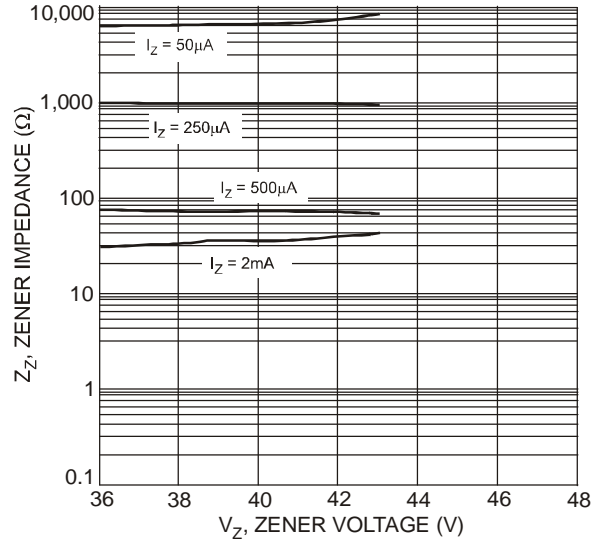

Fig. 15 Typical Zener Impedance Characteristics, DDZ36 - DDZ43

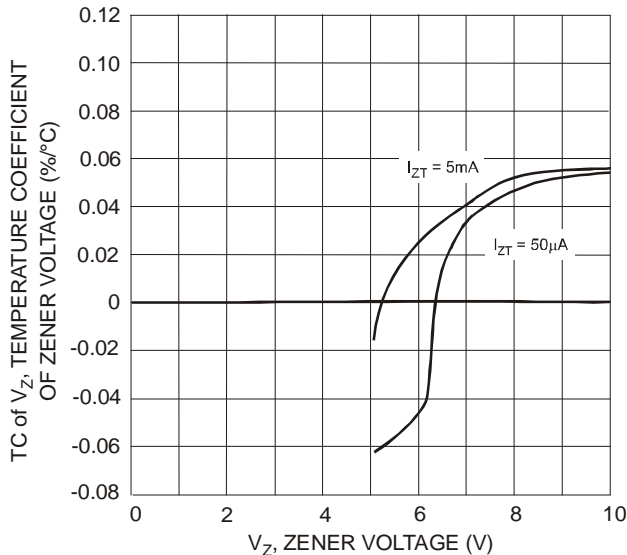

Fig. 16 Typical Temperature Coefficient of Zener Voltage vs. Zener Voltage, DDZ5V1B-DDZ10C

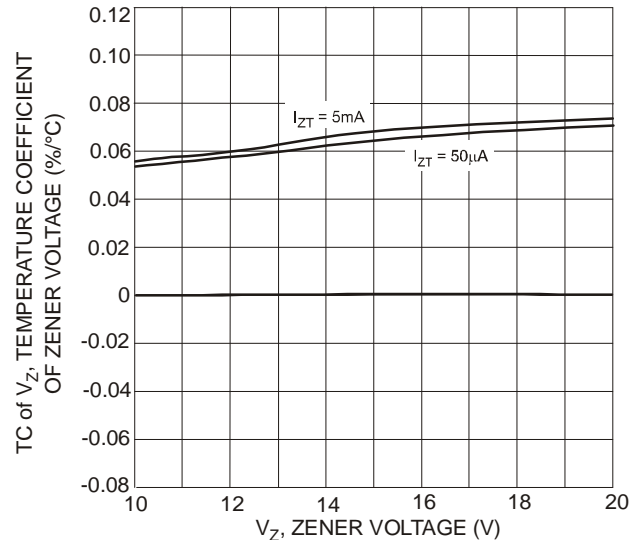

Fig. 17 Typical Temperature Coefficient of Zener Voltage vs. Zener Voltage, DDZ10C-DDZ20C

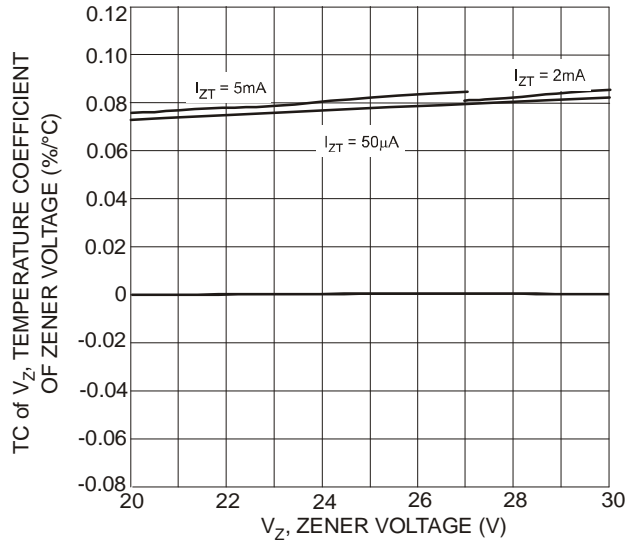

Fig. 18 Typical Temperature Coefficient of Zener Voltage vs. Zener Voltage, DDZ20C-DDZ30D

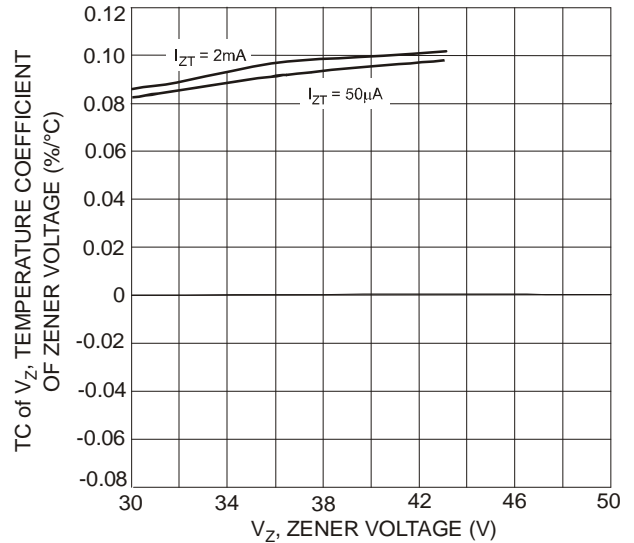

Fig. 19 Typical Temperature Coefficient of Zener Voltage vs. Zener Voltage, DDZ30D-DDZ43

Ordering Information (Note 8)

Part Number	Case	Packaging
DDZ(V _Z Rank)-7*	SOD-123	3000/Tape & Reel

* Example: The part number for the 6.2 Volt device would be DDZ6V2B-7.

Notes: 8. For packaging details, go to our website at <http://www.diodes.com/datasheets/ap02007.pdf>.

Marking Information



xx = Product Type Marking Code
(See Electrical Characteristics Table)
YM = Date Code Marking
Y = Year (ex: T = 2006)
M = Month (ex: 9 = September)

Date Code Key

Year	2003	2004	2005	2006	2007	2008	2009	2010	2111	2012
Code	P	R	S	T	U	V	W	X	Y	Z

Month	Jan	Feb	Mar	Apr	May	Jun	Jul	Aug	Sep	Oct	Nov	Dec
Code	1	2	3	4	5	6	7	8	9	O	N	D

Package Outline Dimensions

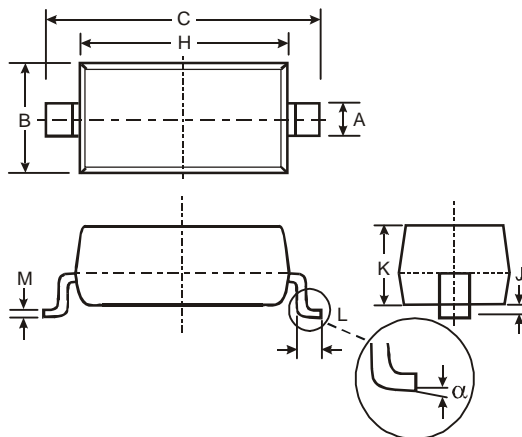

SOD-123		
Dim	Min	Max
A	0.55 Typ	
B	1.40	1.70
C	3.55	3.85
H	2.55	2.85
J	0.00	0.10
K	1.00	1.35
L	0.25	0.40
M	0.10	0.15
α	0	8°
All Dimensions in mm		

Suggested Pad Layout

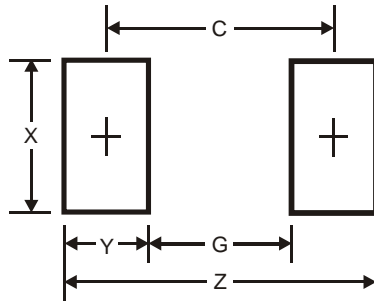

Dimensions	Value (in mm)
Z	4.9
G	2.5
X	0.7
Y	1.2
C	3.7

IMPORTANT NOTICE

Diodes Incorporated and its subsidiaries reserve the right to make modifications, enhancements, improvements, corrections or other changes without further notice to any product herein. Diodes Incorporated does not assume any liability arising out of the application or use of any product described herein; neither does it convey any license under its patent rights, nor the rights of others. The user of products in such applications shall assume all risks of such use and will agree to hold Diodes Incorporated and all the companies whose products are represented on our website, harmless against all damages.

LIFE SUPPORT

Diodes Incorporated products are not authorized for use as critical components in life support devices or systems without the expressed written approval of the President of Diodes Incorporated.